

Article number: 2314449452

Description: E+G polyamide wheel

RE.F8-150-RSL - loose wheel with ball bearings in polyamid

Measures

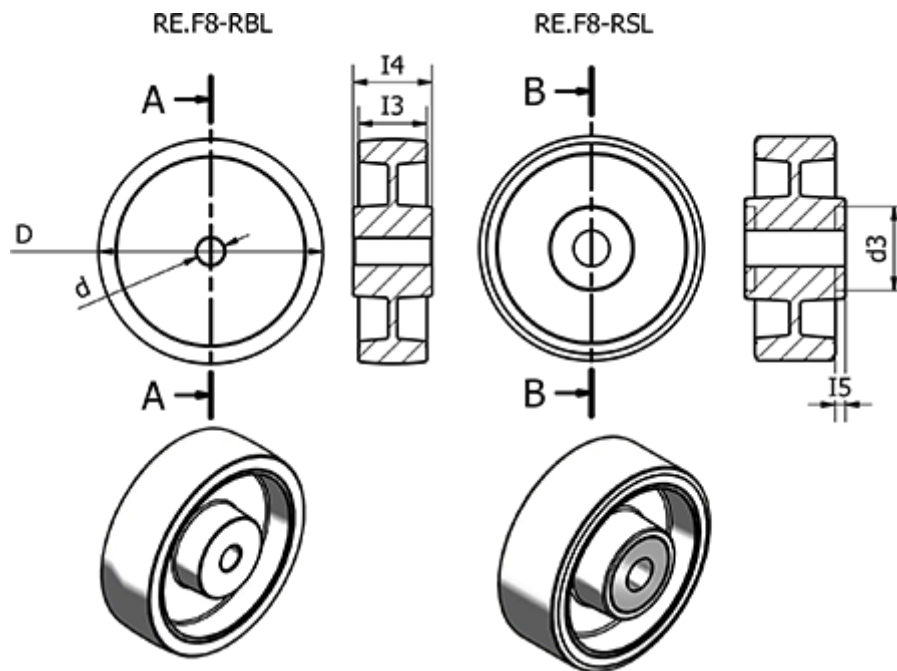

Code	= -	Rolling resistance (N)	= 4550
d	= 150	Static load	= 8000
d3	= 47	Type	= RE.F8-150-RSL
Dynamic carrying capacity (N)	= 7500	Wight (g)	= 740
I3	= 45		
I4	= 56		
I5	= 13		